

design Studio Tecnico Pacini & Cappellini

Ines

Sedia con struttura in massello di frassino, seduta e schienale rivestiti in ecopelle o tessuto della collezione.

chair
5447

Chair with structure in solid ash, seat and backrest covered in eco-leather or fabric of the collection.

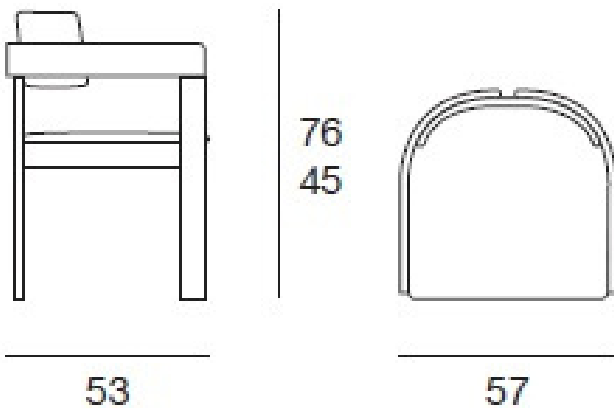

finiture - finishings

I colori riprodotti sono da ritenersi puramente indicativi.
The colours shown here should be taken as purely indicative.

laccato opaco poro aperto
open pore matt lacquered

legno
wood

L21
bianco opaco
matt white



NK
noce canaletto
canaletto walnut

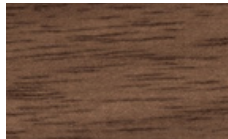

L29
madreperla opaco
matt pearl



NC
frassino tinto noce
ash stained walnut

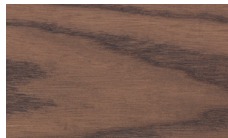

L23
cappuccino opaco
matt cappuccino



TB
frassino o noce canaletto
tinto tabacco
*ash or canaletto walnut
stained tobacco*

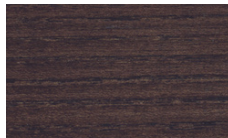

L28
grigio medio opaco
matt medium grey



WG
frassino o noce canaletto
tinto wengè
*ash or canaletto walnut
stained wengè*

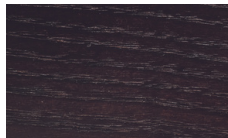

L25
grigio fumo opaco
matt smoke grey



MK
frassino o noce canaletto
tinto moka
*ash or canaletto walnut
stained moka*

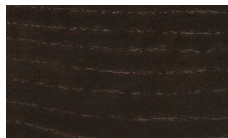

L22
nero opaco
matt black



TN
frassino o noce canaletto
tinto ner
*ash or canaletto walnut
stained black*

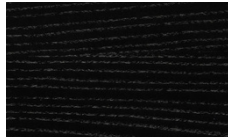

L24
rosso opaco
matt red



Su richiesta è possibile
abbinare la tinta del
frassino tinto noce al
noce canaletto (NC + NK)

*On request it is possible
to match the finishing
ash stained walnut with
canaletto walnut (NC +
NK)*