

design Giuliano e Gabriele Cappelletti

ten for ten

Tavolo da pranzo con strutture in massello di noce canaletto o frassino. Piano in vetro naturale temperato (sp. 10 o 12 mm) con piastre elettrosaldate.
Dining table with structures in solid canaletto walnut or ash. Top in clear tempered glass (10 or 12 mm th.) with electro welded supports.

table
cod.5492

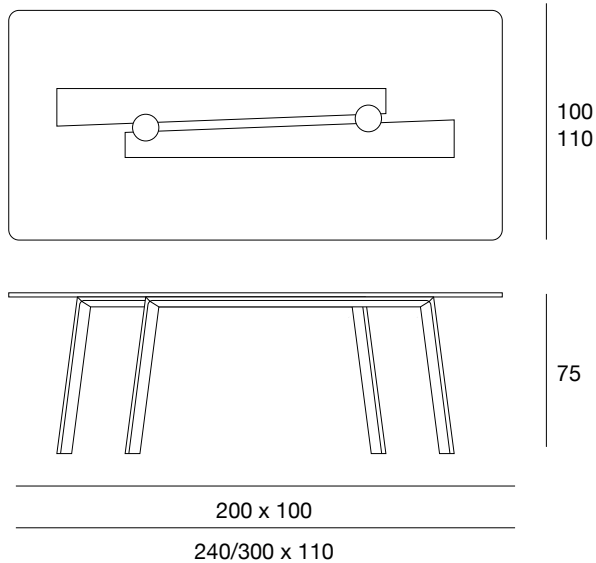

laccato opaco poro aperto
open pore matt lacquered

legno
wood

L21

bianco opaco
poro aperto
*open pore
matt white*



NK

noce canaletto
canaletto walnut

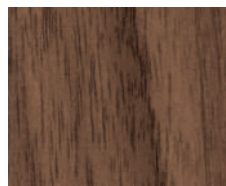

L29

madreperla opaco
poro aperto
*open pore
matt pearl*



NC

frassino tinto noce
ash stained walnut

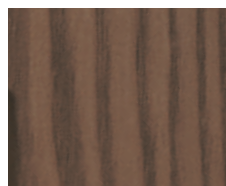

L23

cappuccino opaco
poro aperto
*open pore matt
cappuccino colour*



TB

frassino o noce
canaletto tinto tabacco
*ash or canaletto
walnut stained tobacco*

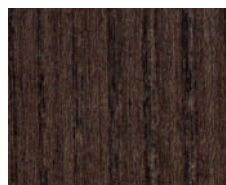

L28

grigio medio
poro aperto
*open pore matt
medium grey*



WG

frassino o noce
canaletto tinto wengè
*ash or canaletto
walnut stained wengè*

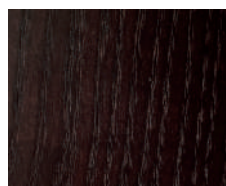

L25

grigio fumo opaco
poro aperto
*open pore matt
smoke grey*

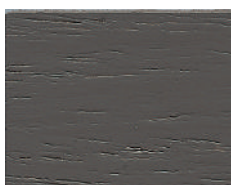

MK

frassino o noce
canaletto tinto moka
*ash or canaletto
walnut stained moka*



L22

nero opaco
poro aperto
*open pore
matt black*



TN

frassino o noce
canaletto tinto nero
*ash or canaletto
walnut stained black*

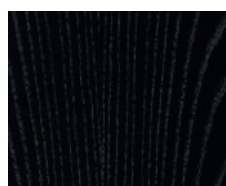

L24

rosso opaco
poro aperto
*open pore
matt red*

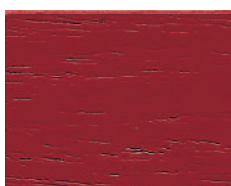

I colori riprodotti sono da ritenersi puramente indicativi.
The colours shown here should be taken as purely indicative.